

COMO



B111



CLUB  
FOLDING BACK  
RELAX  
PUSHBACK  
360°TURN

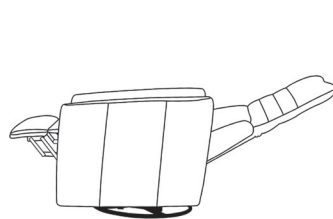

Relax

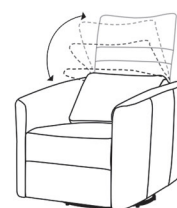

Folding back

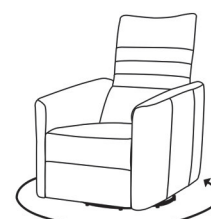

360°

## COLORS



MOZART

#FX007  
Marble Grey



#FX004  
Dark Grey



# SPECIFICATIONS

## IT Tecnica

### Struttura:

Pino massiccio, compensato di pioppo, meccanismo di metallo.

### Imbottitura:

-Seduta: Schiuma di poliuretano 32kg/m<sup>3</sup> densità, Dacron.

-Schienale: Schiuma di poliuretano 28kg/m<sup>3</sup> densità, Dacron.

-Braccioli: Schiuma di poliuretano 28kg/m<sup>3</sup> densità, Dacron.

Sospensione: Molle Nosag, cinghie elastiche.

Rivestimento: Tessuto Mozart, 100% polyester.

Piedi: Metallo.

## FR Technique

### Structure:

Pin massif, contreplaqué de Peuplier, mécanisme en métal.

### Garnissage:

-Assise: Mousse polyuréthane 32kg/m<sup>3</sup> densité, Dacron.

-Dossier: Mousse polyuréthane 28kg/m<sup>3</sup> densité, Dacron.

-Accoudoirs: Mousse polyuréthane 28kg/m<sup>3</sup> densité, Dacron.

Suspension: Ressorts Nosag, sangles élastiques.

Revêtement: Tissu Mozart, 100% polyester.

Pieds: Métal.

## NL Technisch

### Structuur:

Massief Hout, houtvezelplaat, mechanisme in metaal.

### Opvulling:

-Zit: Schuim polyurethaan 32kg/m<sup>3</sup> densiteit, Dacron.

-Rug: Schuim polyurethaan 28kg/m<sup>3</sup> densiteit, Dacron.

-Armen: Schuim polyurethaan 28kg/m<sup>3</sup> densiteit, Dacron.

Ondersteuning: Nosag veren, elastische banden.

Bekleding: Stof Mozart, 100% polyester.

Poten: Metaal.

## EN Technical

### Structure:

Solid wood, Poplar Fibreboard, Steel Mechanism.

### Padding:

-Seat: PU foam 32kg/m<sup>3</sup> density, Dacron.

-Back: PU foam 28kg/m<sup>3</sup> density, Dacron.

-Arm rests: PU foam 28kg/m<sup>3</sup>, Dacron.

Suspension: Nosag springs, elastic webbing.

Upholstery: Fabric Mozart 100% polyester.

Legs: Metal.

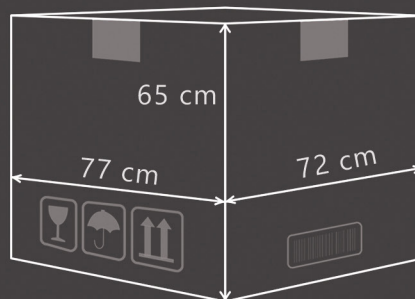
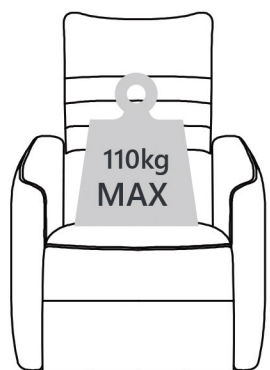
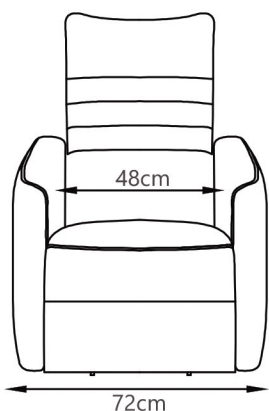
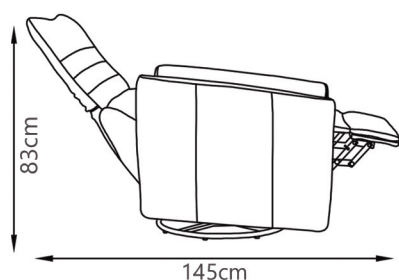
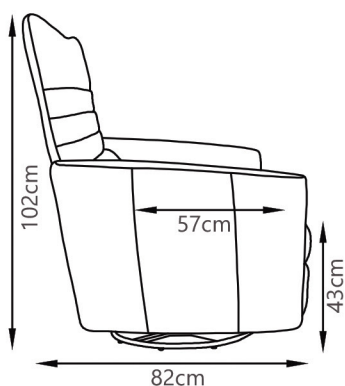

N.W.: 36 KG

G.W.: 40 KG

CBM.: 0,36 m<sup>3</sup>

Colli 1: 77cm x 72cm x 65cm (LxWxH) G.W. 40 KG

Loadability: 180pcs / 40HC container